

Article number: 54301306

Description: LDK Rod end PHS 6

Measures

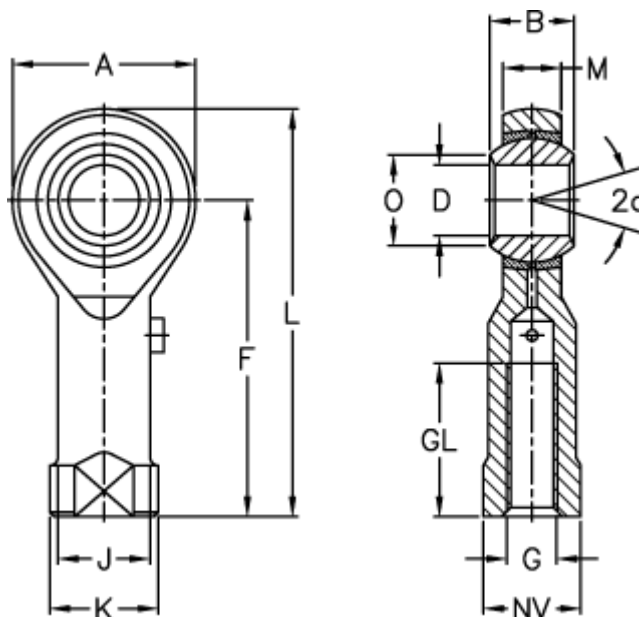

A	= 18	J	= 10.0
a (degrees)	= 13	K	= 13
B	= 9	L	= 39
D	= 6	M	= 6.75
Dynamic load C (kN)	= 3.2	NV	= 11
F	= 30	O	= 8.90
g	= M6	Static load C0 (kN)	= 9.9
GL	= 13	Weight (g)	= 25.0